



## Des Moines WoodTurners Chapter Meeting Announcement & Newsletter

April 2026 a 501(c)(3) Non-profit Organization Bulletin 2026-04

### April 11th Demonstration

**Don Kruse**

### Inside - Out Turning



**Don** taught Industrial Arts for 34 years in Iowa. He has been turning for over 40 years and been doing segmented turning for the past 20 years.

He started doing inside - out turning for Christmas decorations. He saw a lamp design and thought it looked like inside out. He has made 16 of them in the last five years.



### Future Educational Programs

May 9th: Brian Noble-Marx — Ovoid Bowls and Small Lidded Boxes  
Morning and Afternoon Presentations, Website: [www.noblemarx.com](http://www.noblemarx.com)

Sept. 12: TBA

October 10: Phil Holtan returns

### Des Moines Woodturners thanks our new Volunteers

Assistant Webmaster: **Dana Oredson**

Video Assistants: **Duane Strempe** and **Philip Blobaum**

Treasurer: **Vern Kinderknecht** (starting 2027)

**More Volunteers Needed**  
**Dennis Anderson, President**

A huge thank you to all the dedicated members who help make DMWT a success! It truly takes a collective effort to keep our club running smoothly.

Especially for those of you who are not currently involved beyond attending meetings, we would love for you to volunteer to help. It is also a great way to get to know club members. We have some immediate needs to identify members to step into key roles later this year:

- Program Chairman
- Newsletter Editor

Additionally, our State Fair project is coming up. This vital fundraiser is key to keeping club dues affordable. We need enthusiastic volunteers for:

- Setting up and tearing down the booth
- Pack, price, and move wood turnings to the fair
- Scheduling and coordinating demonstrators to work at the fair
- Working shifts at the fair, both demonstrating and sales
- Turning the wood products the club sells (now is the time to be doing this)

Your contribution makes a real difference. Please reach out to me or any board member to determine where your skills can best be used!

**Support the Club - Turn Trees and \$3 Pens for the State Fair**

The greatest need is **Trees** and **Funky Pens**.

The trees should be at least 6 inches tall, but otherwise no limits.

The Funky Pens sell for \$3. So, don't spend a lot of time.

Tree and Funky Pen blanks are available at Valley West.

**DWMT Board Meeting**  
**++All are Invited++**

Board meetings are open to all members.

The next board meeting **April 22nd** at approximately 10:30 AM at Valley West.

**Membership News - New Members**

The club has welcomed 30 (30!) new members in 2025. Welcome all.

The most recent:

**Michael Johnson - Urbandale**

**Tim Devine - Des Moines**

**Larry Lynch - Des Moines**

## Turning Challenge for April 11th Wooden Egg

**You Tube Video:** <https://www.youtube.com/watch?v=P8JoFvpEmQ>

Please put your name on the back of the Turning Challenge card or on the bottom of your turning.

Tape the Turning Challenge Card to the bottom of your turning.



### TOOLS NEEDED

- SPINDLE ROUGHING GOUGE
- PARTING TOOL
- SPINDLE GOUGE (3/8" or 1/2")
- 4 JAW CHUCK (SCROLL CHUCK)

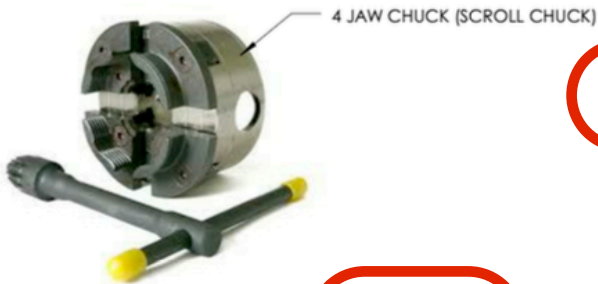

MOUNT BETWEEN CENTERS

**DO NOT TURN ALL FLAT AWAY**

Step 1

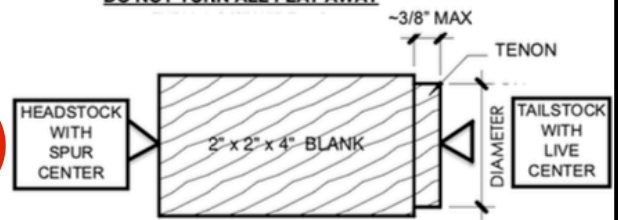

TENON DIAMETER IS SIZED TO FIT CHUCK JAWS.  
TENON SHAPE IS STRAIGHT OR DOVETAIL TO FIT CHUCK JAWS.

Step 2

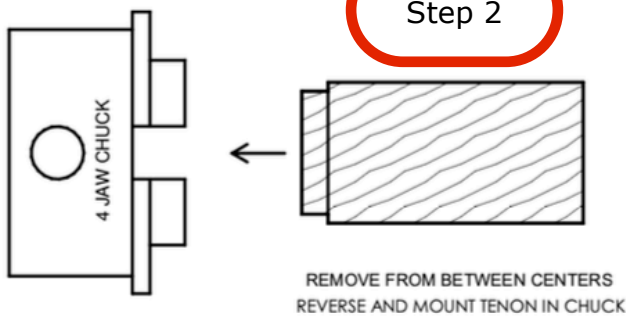

Step 3

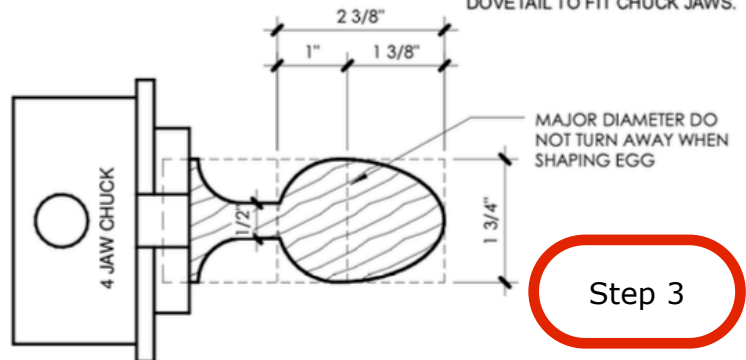

ONLY AFTER EGG IS SHAPED, SANDED & FINISHED PART OR SAW OFF A LITTLE PROUD, THEN SAND AND FINISH.

# WOODEN EGG

SCALE: 6" = 1'-0"

## DMWT You Tube Channel

Our dedicated club videographer, **Tom Baker**, has been working tirelessly to create a YouTube channel for our club videos. Currently, there are a handful of videos available, and Tom will continue to add more, starting with the most recent recordings and working back to older ones.

Please note that not all videos from our meetings may be uploaded, primarily because many professional turners monetize their demos and may not grant us permission to share those recordings on our channel.

We encourage you to subscribe to our YouTube channel, as this will not only keep you updated on the latest content but will also enhance our visibility on the platform.

Here's the link to our channel:

[Des Moines Woodturners YouTube Channel.](#)

We believe you will appreciate the effort **Tom** is putting into this project.

Be sure to subscribe and enjoy the videos!

## Tool Exchange and Sale - Each Wednesday Morning Networking Meeting

Do you have extra woodworking tools sitting unused in your shop?

Want to trade them for something new or clear some space?

The Rules:

- Members Only: Participation is restricted to current club members.
- Private Sales: All money or trade negotiations are strictly between the buyer and seller.
- Woodworking Focused: Items must be related to wood-related tools or accessories.
- Size Limits: Items must be small enough to carry in. For larger machinery, please leave it in your vehicle and bring a photo to display.
- Setup: Tables will be provided in the meeting room for your items.
- Labeling: Please clearly mark each item with the seller's name and asking price.
- Clean Up: All unsold items must be taken home at the end of the meeting.



## Stan Merrell demonstration, March 14, 2026

### USING RESINS IN WOOD TURNING

**Stan** began the demonstration by showing all the different ways he uses resin. He displayed bowls of all shapes with resin in the voids of the bowls. He made bowls just using resins and other materials put into the resins. Some of the materials he added to resin bowls were deer antlers, shells, marbles, and wood chips. Resins give a turner an opportunity to show creativity and uniqueness in their turnings.

He is using resins that are two parts resins which are added together in equal proportions. He mixes each part by weight by using a scale as the equal amount of each part is very important to get a good cure. He mixes the resin using drill for at least two minutes. He can add pearlized additive to color the bowl. Stan is using plastic bowls to form the bowl shape; one for the outside of the bowl and the other one for the inside of the bowl. He uses "apel silicone mold release" to make it easier to get the bowl out of the form. Stan poured the resin mixture into the forms slowly to avoid getting air bubbles in the resin. Additional layers can be added to fill the form. He then places the mold in a pressure pot for 24 hours at 60 psi.

After the bowl resin is cured the bowl can be removed from the mold and finished turned as you would any bowl on the lathe with conventional turning tools. He demonstrated this with a resin bottle stopper placed on the lathe using a chuck. Using carbide tools seem to get a better cut or a smoother surface but steel gouges can be used but they will dull quickly. Using higher speeds is better than turning slowly. He began sanding with a courser grit and ended sanding at a 12,000 grit. The surface was highly polished after sanding without any sanding marks.

He explained that a turner who wanted to begin doing resin casting would need a pressure pot, a gram scale, two-part resin material, and various forms and mixing containers. This equipment would cost about \$1200. Stan demonstrated the many ways that resins can be used in turning. If a turner is interested in resin molding, Stan gave them enough information to help them decide if they wanted to pursue using resins in turning. His demonstration was very informative and helpful to understand how resins can be used in turning.

**Will Zitterich**, Secretary.

### Turning Blanks for the Iowa State Fair Only

The Dick Meuler sale was very successful, however there is a lot of wood left. The family has donated this to the woodturners and woodworkers. Several pieces have been taken to the mall. As always, the wood in the very back room where the restroom is free for the taking. Several nice pieces have been placed there.

Other pieces are back by the treasurer's desk that are only for the state fair and are to be checked out through **Mark Hayes**. Some very nice turning pieces are there. Hopefully you can help us out with turning an item for the fair.

### Judging Entries to the Iowa State Fair

On the **next page** there is a sample judging form for woodturning. This is the form **Tom Whalley** uses when judging. (**Tom** will not be judging woodturner entries at the State Fair.) The form may help you look at your turning through a judge's eye.

## **Sample - Woodturning Judging Criteria**

### **Created by Tom Whalley**

#### **Judging elements and descriptions**

- 1. Overall design appeal based on first impression** **Score range: 1 - 5**
- a. First impression!
  - b. From an artistic point of view, does the piece have a wow factor?  
(good or bad doesn't matter, does it exist – yes or no)
- 2. Creativity – embellishments, uniqueness, etc.** **Score range: 1 - 5**
- a. Level of creativity - imagination
  - b. How well did the creativity blend into the project? Does it all work?
  - c. If there are embellishments, do they overpower the piece?
  - d. How well does it stand out in a crowd?
- 3. Woodmanship - are any of the following noticeable?** **Score range: 1 - 20**
- a. Does it have a single focal point?
  - b. Sanding rings
  - c. Feathering of the wood
  - d. Chips or visible catches
  - e. Does the piece flow – change directions at the bottom?
  - f. Outside – non-continuous curves
  - g. Poorly fitting joints (segmented)
  - h. Bumps, dimples or raised areas visible in the bottom (from the inside)
  - i. Is the bottom of the piece properly finished (sanded, etc.)?
  - j. Poorly filled voids if voids are filled
  - k. Excessively thick walls
  - l. Does it set solidly on the table or does it rock?
- 4. Finishing** **Score range: 1 - 20**
- a. Does the finishing process match the piece?
  - b. Are there any visible runs or bubbles?
  - c. Are there any “brush stokes” showing
  - d. Is there any exposed glue showing anywhere?
  - e. Does the finish appear too “waxy” or “oily”?

**TOTAL SCORE: \_\_\_\_\_**

## Help Needed

**Jerry Battles, 515 201-5088**

Jerry needs help reproducing a small piece of trim on a clock he is restoring. If you can make it, or know of a place that might have a replacement, please contact him at the above number.



## Box Elder Blanks for Sale

**Tom Newsom  
Millie Wood Works  
4725 NW 50th  
Des Moines IA**



## Training News

### Woodturning Classes

**General Information:** You will receive an information packet by email approximately 1 month before the class. It contains a list of required accessories, location and safety information. A reminder will arrive about 1 week before the class. The fee is collected on the day of the class. There is no penalty for cancellation, but please let us know ASAP if you have to cancel.

**Basic Woodturning:** If you have not taken Basic Woodturning you will find it useful if you're new to turning, been away from the lathe for awhile or would just like a refresher. Enhance your spindle turning skills. It is a fun day and a confidence builder. In addition, it is the prerequisite for the other courses. DWMT provides the tools and wood. Homework is assigned between classes so you will need access to a lathe. Basic Woodturning is two consecutive Mondays, 8:30 to 5. Cost: \$40.

**Basic Bowl Turning:** This class touches on basics of wood harvesting, differences from spindle turning, and introduces the bowl gouge. You will practice on a Poplar blank before turning your Hard Maple bowl. The class is one full day. DMWT provides the tools and blanks, you provide the accessories and face shield. This is a one day class. Cost: \$20.

**Basic Segmenting:** This class will cover the basics of making segmented projects, from calculating segment angles and sizes, ring diameters needed, segment wood prep, gluing and clamping, to accurate cutting fixtures. You'll glue together furnished pre-cut segments and clamp them. Turning will be demonstrated but students won't be using the lathe in the class. Pre-cut segments for glue-up practice will be furnished. Bring paper and pencil to take notes. This is a one day class. Cost: \$20.

**Basic Skew Chisel:** This class will introduce students to the proper techniques and use of the tool as well as sharpening. Students will furnish their own skew chisel(s) (3/4 inch and up preferred). We will use the same accessories as in the Basic Woodturning Class. This is a one day class. Cost: \$20.

**Basic Sharpening:** The sharpening class will use lathe mounted sandpaper sharpening wheels and wooden dowels to teach the techniques of sharpening. This class is primarily for gouges but will also touch on a variety of other common traditional turning tools such as parting tools, skew, bedan and scrapers. In addition, sharpening hollowing tools, thread chasers, hook tools and common flat carbide cutters will be discussed. After practice, students will have the opportunity to sharpen their own tools using the Oneway Wolverine Sharpening system and CBN wheels. This is a one day class. Cost: \$20.

Please contact John Amberg at [johnaamberg@yahoo.com](mailto:johnaamberg@yahoo.com) for further information or to sign up.

### Are you signed up for a Woodturning Class?

Please check the Training Classes page. There have been a number of changes in class assignments. Please make sure you are in the right class at the right time. If there is an error, please email [John Amberg](mailto:John Amberg) ASAP.

## 2026 Training Classes

If you would like to enroll, email John Amberg at [johnaamberg@yahoo.com](mailto:johnaamberg@yahoo.com)  
or see me at the meetings.

All Classes are on Mondays from 8:30 am to 5 pm.

Basic Woodturning	Basic Woodturning	Basic Woodturning	Basic Woodturning
March 9 & 16th, 2026	April 20 & 27th 2026	September 14 & 21, 2026	October 19 & 26, 2026
Bob Jackson Tim Ingram Elijah Ingram Dustin Smith	Herman Riva Dennis Schneider Curt Barclay Dana Oredson	Kevin Roozeboom Larry Bailiff Gary Reed Kepler Johnson	Philip Blobaum Tim Devine 2 1

Basic Skew	Basic Segmenting	Basic Segmenting	Basic Skew
March 23, 2026	May 4, 2026	September 28, 2026	November 2, 2026
Herman Riva Scott Smith Mark Hayes Bob Jackson	Scott Smith Tom Golding Dana Oredson 1	Herman Riva 3 2 1	Brent Heuer Curt Barclay Herman Riva Scott Core

Basic Bowl	Basic Bowl	Basic Bowl	Basic Bowl
March 30, 2026	May 11, 2026	October 5, 2026	November 9, 2026
Bob Jackson Tim Ingram David Breese	Herman Riva Dennis Schneider Curt Barclay Dana Oredson	Larry Bailiff Gary Reed Kepler Johnson Gene Davis	Philip Blobaum John Carman Tim Devine Dustin Smith

Basic Sharpening	Basic Sharpening	Basic Sharpening	Basic Sharpening
April 6, 2026	May 18, 2026	October 12, 2026	November 16, 2026
Tim Ingram Scott Smith Sharon Squibb Bob Jackson	Brad Huyser Jeff Newhook Curt Barclay Joe Kaskadden	Greg Alberts Dana Oredson Herman Riva Dustin Smith	Larry Bailiff Gary Reed Kepler Johnson Philip Blobaum

## Training Class Graduates



**Basic Woodturning, March 9 and 16**  
**Bob Jackson, Tim Ingram, Elijah Ingram, Dustin Smith**



**Basic Skew, March 23**  
**Herman Riva, Scott Smith, Bob Jackson, Mark Hayes**



**Basic Bowl, March 30**  
**Bob Jackson, Tim Ingram, David Breese**

## Mentoring Program

The Des Moines Woodturners Inc. (DMWT) invites members to use the Mentor Program. Below is a list of volunteers, members in good standing, who are willing to share their experience and answer specific questions to help you with a particular problem. Each mentor's strengths are noted along with their name and city location. Select who might be best to contact, based on your questions and how far they are from you. As volunteers, it will be up to the mentor to decide if they can help, whose shop will be used and what mentoring will look like based on the need.

Webpage: [DMWT Mentoring Program](#)

**Dan Carlson**, Clive  
Phone 515-720-0637  
[dano1466@yahoo.com](mailto:dano1466@yahoo.com)

Dan will mentor in these areas:

1. Getting started with pen turning
2. Turning small ornaments
3. Turning small lidded boxes
4. Turning seam rippers, letter openers
5. Turning bottle stoppers

---

**Glen Farmer**, Ogden  
Phone 517-395-0317  
[gfarmeriii@yahoo.com](mailto:gfarmeriii@yahoo.com)

Glen will mentor in these areas:

1. Bowl turning
2. Ornaments
3. Hollow forms
4. Coloring
5. Platters
6. Spindle work
7. Boxes
8. Harvesting wood/Blank cutting

---

**LeRoy Monson**, Waukee  
Home Phone: 515-987-1655  
Cell Phone: 515-745-9098  
[monsonlg@aol.com](mailto:monsonlg@aol.com)

LeRoy will mentor in these areas:

1. Spindle (including duplicating)
2. Bowls
3. Platters
4. Lidded box
5. One-way sharpening and set-up
6. Tool control
7. Bandsaw and lathe maintenance

**Tad Tadlock**, Winterset  
Phone: 515-201-7403  
[tad4tahoe@aol.com](mailto:tad4tahoe@aol.com)

Tad will mentor in these areas:

1. Natural & naked edge bowls
2. Large & small bowls
3. Platters
4. Boxes
5. Open void vessels
6. Sharpening

---

**Jack Kennedy**, Winterset  
Phone: 515-462-3141j  
[jkennedywinterset@att.net](mailto:jkennedywinterset@att.net)

Jack will mentor in these areas:

1. Closed Segment Bowls
2. Open Segment Bowls

---

**Jack Rolison**, Ottumwa  
Phone: 641-683-5647  
[jd.rolison@outlook.com](mailto:jd.rolison@outlook.com)

Jack will mentor in these areas:

1. Bowl turning
2. Finishing
3. Coloring
4. Sharpening

## Educational Opportunities

### DMWT Woodturning Scholarship

The Des Moines Woodturners offer a scholarship program for the benefit of chapter members. Woodturning can be an expensive endeavor. The cost of equipment such as a lathe, bandsaw, chainsaw, sharpening system, buffing system and the myriad of items like drive centers, scroll chucks, live centers, adapters, jaws, and faceplates can mount rapidly. In addition is the cost of turning tools, embellishing tools, specialty tools and a host of accessories, supplies and finishing products, not to mention the cost of wood if you don't have the capacity to harvest your own.

By the same token, three and five day woodturning educational events are also expensive when located out-of-state. Travel costs, lodging and tuition can easily run \$1,000 to \$1,700 per event.

This scholarship is not intended as a source of financial aid for those who might otherwise not be able to afford the educational experience. Instead, it is offered as an incentive to those serious about woodturning who are willing to expand their skills and knowledge and bring those skill-sets back to share with our members in a variety of ways. The scholarship can provide recipients a 25% to 50% discount toward the overall cost of their attendance expenses.

The purpose of the scholarship is to expand personal woodturning skills and knowledge and share their experience with fellow members by:

- Attending Chapter events and sharing their learning experience.
- Showing examples of their work as a result of their learning experience.
- Demonstrating what they learned at a chapter meeting, event, or class.
- Sharing their overall learning experience and confidence building experience.
- Encouraging members to expand their woodturning skills via similar educational experiences.
- Volunteering for Chapter leadership positions (wide variety of opportunities).

### American Association of Woodturners (AAW)

We recommend an AAW membership because it offers many woodturning resources:

- \*\* Six issues of American Woodturner magazine each year.
- \*\* On-line access to all previous issues of American Woodturner and FUNdamentals.
- \*\* On-line access to videos and many other learning resources.

[AAW Membership Join or Renew](#)  
American Association of Woodturners  
222 Landmark Center,  
75 5th Street  
W St. Paul, MN 55102

Phone: (651) 484-9094 direct or toll free US (877) 595-9094

Email: [memberservices@woodturner.org](mailto:memberservices@woodturner.org).









Website: <https://www.woodturner.org/>

## Des Moines Woodturners Calendar

Event	Date	Refreshments
Chapter Meeting	April 11, 2026, 1 PM	Larry Lynch
Networking Meeting	April 22, 2026, 9:30 AM	Daniel Henderson
Chapter Meeting	May 9, 2026, 1 PM	Myles Hegstrom
Networking Meeting	May 27, 2026, 9:30 AM	Tom Golding
America's State Fair (proposed)	May 29 to July 19	Iowa State Fairgrounds (America 250th)
Chapter Meeting	June 13, 2026, 1 PM	Roger Nurnberg
Networking Meeting	June 24, 2026, 9:30 AM	Dan Carlson
Chapter Meeting	July 11, 2026, 1 PM	Scott Smith
Networking Meeting	July 22, 2026, 9:30 AM	
Iowa State Fair	August 13 - 23, 2026	Iowa State Fairgrounds
Networking Meeting	August 26, 2026, 9:30 AM	
Chapter Meeting	September 12, 2026, 1 PM	Michael Johnson
Networking Meeting	September 23, 2026, 9:30 AM	Myles Hegstrom
Chapter Meeting	October 10, 2026, 1 PM	Dan MacAlpine
Networking Meeting	October 28, 2026, 9:30 AM	Kepler Johnson
Chapter Meeting	November 14, 2026, 1 PM	Maurice & Bryan Herold
*Networking Meeting	*November 18, 2026, 9:30 AM	
Chapter Meeting	December 12, 2026, 1 PM	John Amberg
*Networking Meeting	*December 16, 2026, 9:30 AM	
Chapter Meeting	January 9, 2027, 1 PM	
Networking Meeting	January 27, 2027, 9:30 AM	
Chapter Meeting	February 13, 2027, 1 PM	
Networking Meeting	February 24, 2027, 9:30 AM	
Chapter Meeting	March 13, 2027, 1 PM	
Networking Meeting	March 24, 2027, 9:30 AM	
Chapter Meeting	April 10, 2027, 1 PM	
Networking Meeting	April 28, 2027, 9:30 AM	
* Rescheduled due to Holiday		



## Board Members and Officers

President: <b>Dennis Anderson</b> (515) 975-8573 <a href="mailto:dennis.anderson.dca@gmail.com">dennis.anderson.dca@gmail.com</a>		Treasurer: <b>Stan Merrell</b> (515) 491-5411 <a href="mailto:srmerrell1@gmail.com">srmerrell1@gmail.com</a>	
Vice President: <b>Mark Hayes</b> (515) 520-0826 <a href="mailto:mahayes@netins.net">mahayes@netins.net</a>		Training: <b>Tad Tadlock</b> (515) 201-7403 <a href="mailto:tad4tahoe@aol.com">tad4tahoe@aol.com</a>	
Secretary: <b>Will Zitterich</b> (515) 232-1765 <a href="mailto:wzitterich@mchsi.com">wzitterich@mchsi.com</a>		Membership: <b>Dan Carlson</b> (515) 720-0637 <a href="mailto:dano1466@yahoo.com">dano1466@yahoo.com</a>	
Programs: <b>Tara Kinder</b> (319) 939-1727 <a href="mailto:tjkinder1994@gmail.com">tjkinder1994@gmail.com</a>		Safety: <b>Mike Hamilton</b> (515) 822-6771 <a href="mailto:kmhamilton9@msn.com">kmhamilton9@msn.com</a>	

## Links to the DMWT Website

<a href="#">Meetings and Events</a>	<a href="#">Woodturning Articles and Plans</a>
<a href="#">Chapter Library List</a>	<a href="#">Contact Board Members and Volunteers</a>
<a href="#">Membership Application Form</a>	

## Des Moines Woodturners Wearables



Members wanting Des Moines Woodturners logo embroidered on clothing are advised to purchase shirts, sweatshirts or turning smocks of their choice and style. These must be BRAND NEW and UNWASHED and can be delivered to any officer or board member. When enough items are collected to meet minimums, they will be taken to the embroiderer. Be sure to attach a note with your name to the collar of each garment submitted indicating if and how you want your name embroidered along with the Chapter logo. The DM Woodturners logo and your name costs \$16.00 paid at the time the item is given to Rob Beattie. Chat with **Rob Beattie** if you have questions. 515-282-4532 or [beattie.r@mchsi.com](mailto:beattie.r@mchsi.com).

## Membership Benefits - Supplier Discounts

One of the benefits of DMWT club membership are discounts with participating suppliers. We strongly encourage you to use local suppliers whenever possible. Before they ring you up, show discount suppliers your Des Moines Woodturners membership card. BUY LOCAL when you can, Mail Order when you have no other choice!!

RightAngleNow	DMWT Member <b>Gil Lea</b> offers a 20% discount on sharpening jigs	<a href="https://www.rightanglenow.com/">https:// www.rightanglenow.com/</a>	515-205-7522
Ace Hardware - Ankeny	10% except for Sale Items, Repair Services, Rental and Gasoline Powered Equipment	3020 SW Oralabor Road Ankeny	515-809-1104
Ace Hardware - Johnston	10% except for Sale Items, Repair Services, Rental and Gasoline Powered Equipment	5800 Merle Hay Rd Johnston	515-276-2854
O-Donnell Ace Hardware	10% Member Discount except for Sale Items, Repair Services, Rentals, Power Tools and Gasoline Powered Equipment	4808 University Des Moines	515-277-0062
O-Donnell Ace Hardware	10% Member Discount except for Sale Items, Repair Services, Rentals, Power Tools and Gasoline Powered Equipment	5715 Hickman Rd Des Moines	515-255-2240
Park Fair Ace Hardware	10% Member Discount except for Sale Items	100 E Euclid Ave Des Moines	515-243-6000
Acme Tools & Equipment - Power Tools	10% Member Discount on Woodworking Accessories. Does not include Sale Items, Power tools or Service and Parts.	629 SW 9th St Des Moines	515-244-4189
Bradley Tool & Fasteners - Sharpening & Equipment Rebuilding	10% Member Discount except sale items, power tools/equipment, tool/equipment parts, tool renovation/repair services.	6250 NW Beaver Dr Ste A4 Johnston	515-331-0878
Sharpening Solutions - Des Moines	Approximate prices are \$1/inch for planer/jointer knives, and \$15 for standard circular saw blades. Additional charges for triple chip grind or high tooth count blades	2614 E Douglas Ave Des Moines	515-577-4535
Sherwin Williams - Paint & Finish	20% discount off all in stock regular price items. 5% discount off in stock sale items. Up to 30% off of the Sher-Wood wood finishes.	Altoona 3770 8th Street SW Ste F	515-967-6974
Sherwin Williams - Paint & Finish	20% discount off all in stock regular price items. 5% discount off in stock sale items. Up to 30% off of the Sher-Wood wood finishes.	Ames 1624 South Duff Ave	515-232-2124
Sherwin Williams - Paint & Finish	20% discount off all in stock regular price items. 5% discount off in stock sale items. Up to 30% off of the Sher-Wood wood finishes.	Ankeny 817 E 1st St	515-964-7890
Sherwin Williams - Paint & Finish	20% discount off all in stock regular price items. 5% discount off in stock sale items. Up to 30% off of the Sher-Wood wood finishes.	Clive 1985 NW 94th St	515-251-2973
Sherwin Williams - Paint & Finish	20% discount off all in stock regular price items. 5% discount off in stock sale items. Up to 30% off of the Sher-Wood wood finishes.	Des Moines 515 16th St *Commercial*	515-280-3365
Sherwin Williams - Paint & Finish	20% discount off all in stock regular price items. 5% discount off in stock sale items. Up to 30% off of the Sher-Wood wood finishes.	Des Moines 5408 Douglas Ave	515-278-0481
Sherwin Williams - Paint & Finish	20% discount off all in stock regular price items. 5% discount off in stock sale items. Up to 30% off of the Sher-Wood wood finishes.	Des Moines 1040 E Army Post Rd Ste A	515-285-0072
Sherwin Williams - Paint & Finish	20% discount off all in stock regular price items. 5% discount off in stock sale items. Up to 30% off of the Sher-Wood wood finishes.	Grimes 2570 E 1st St	515-300-9407
Sherwin Williams - Paint & Finish	20% discount off all in stock regular price items. 5% discount off in stock sale items. Up to 30% off of the Sher-Wood wood finishes.	Marshalltown 105 Nicholas Dr	641-752-0229
Sherwin Williams - Paint & Finish	20% discount off all in stock regular price items. 5% discount off in stock sale items. Up to 30% off of the Sher-Wood wood finishes.	Oskaloosa 117 High Ave W	641-673-8441
Sherwin Williams - Paint & Finish	20% discount off all in stock regular price items. 5% discount off in stock sale items. Up to 30% off of the Sher-Wood wood finishes.	Ottumwa 1231 Theatre Dr	641-684-6564
Sherwin Williams - Paint & Finish	20% discount off all in stock regular price items. 5% discount off in stock sale items. Up to 30% off of the Sher-Wood wood finishes.	Waukee 140 Hickman Rd	515-987-4048
Sherwin Williams - Paint & Finish	20% discount off all in stock regular price items. 5% discount off in stock sale items. Up to 30% off of the Sher-Wood wood finishes.	West Des Moines 830 Grand Ave	515-226-0603
True Value Hardware - West Des Moines	10% Member Discount except for Sale Items, Repair Services, Rental, Electrical and Gasoline Powered Equipment	63rd & Grand West Des Moines	515-279-9905
White Cap Supply - Power Tools & Fasteners	10% Member Discount except for Power Tools and Sale Items.	1631 2nd Ave. Des Moines	515-243-6969
Woodcraft Store - Tools & Supplies - Iowa City	10% Member Discount, except tools that have a cord or battery. There are a few specific brands including Festool and SawStop which exclude even non-powered accessories from our discount, to so be sure to ask before purchase.	3 Escort Lane Iowa City, IA	319-259-7175
Woodcraft Store - Tools & Supplies - Kansas City	10% Member Discount except tools that have a cord or battery plus sale items. There are a few other low margin items that the Discount may not apply to so be sure to ask.	8645 Bluejacket Rd Lenexa, Kansas	913-599-2800
Woodsmith Store - Tools & Supplies	10% Member Discount except for Power Tools and Sale Items	2900 University Ave West Des Moines	515-254-9494